



AutoCreaser Pro XL
AutoCreaser Pro XW
DigiFold Pro XL

Morgana AutoCreaser Pro XL

Crease your digital stock with the AutoCreaser Pro XL and remove all **cracking**

Morgana AutoCreaser Pro XL

The AutoCreaser Pro XL is an easy to use automatic paper creasing system with an efficient vacuum top feeder. The unique creasing rule in the AutoCreaser Pro XL eliminates paper tearing and toner cracking.

Running at a maximum speed of 8,500 A4 sheets hour, with no loss of accuracy, this is our most productive creaser to date. The new AutoCreaser Pro XL takes a sheet size up to 385mm x 1300mm with the table extension.

The new AutoCreaser Pro XL is specifically designed to handle the widest range of media. Morgana's new Adaptive Process Control (APC) monitors sheet feeding in a closed loop process, delivering outstanding performance and reliability. The Feeder continuously checks the paper float zone and automatically makes adjustments on the fly. This is an industry first for a product of this class and ensures highest feed reliability. Operators of all skill levels can get the most out of the AutoCreaser Pro XL.

Key Features

- Edge registered vacuum top feeder with a load capacity of 200mm.
- New sheet separation controlled by optical sensor array - automatically adapts to different media, weights and types
- Automatic feeding parameter selection based on paper size and thickness - simplifies set up regardless of operator skill
- Ultrasonic double sheet detection
- Table extendible up to 1300mm to support popular longer sheet applications
- Powerful creasing unit can accept standard and narrow creasing blades as well as optional cross perforation blades
- Optional second creaser enables up/down creasing in one pass
- Simplified adjustments and blade changeovers without special tools
- Inline rotary perforation, up to five at the same time
- Optional cross perforation unit available

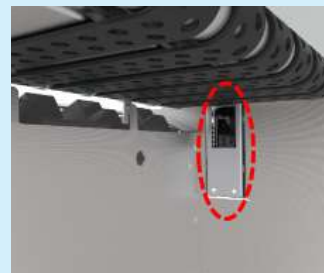

Morgana's Adaptive Process Control technology (APC) measures sheet separation in the "float area" and adjusts tray position and airflow automatically.



Morgana AutoCreaser Pro XL

AutoCreaser Pro XL with intuitive user interface And now with enhanced perforation...

The new intuitive User Interface controls all the main functions of the AutoCreaser Pro XL. Using the screen is simplicity itself. Key in the sheet length (popular sizes are pre-set), touch the fold type for the finished product (letter, gate etc.) and press enter. The AutoCreaser Pro XL will automatically calculate where the creases need to be and set them accordingly. All settings and adjustments are made using the user interface so operation couldn't be easier. An alpha-numeric memory allows an unlimited number of jobs to be stored and named as you choose.

Any changes to the feed method, crease position and engineering settings are all made through the user interface which has been developed and designed to make the AutoCreaser Pro XL easy to operate. You'll process more jobs in less time.

Rotary perforation comes standard on the AutoCreaser Pro range with a wide variety of wheels available to suit all requirements. An optional cross perforating unit can be added for more complex jobs, and multiple perforation layouts can be achieved with the cross perforation option.

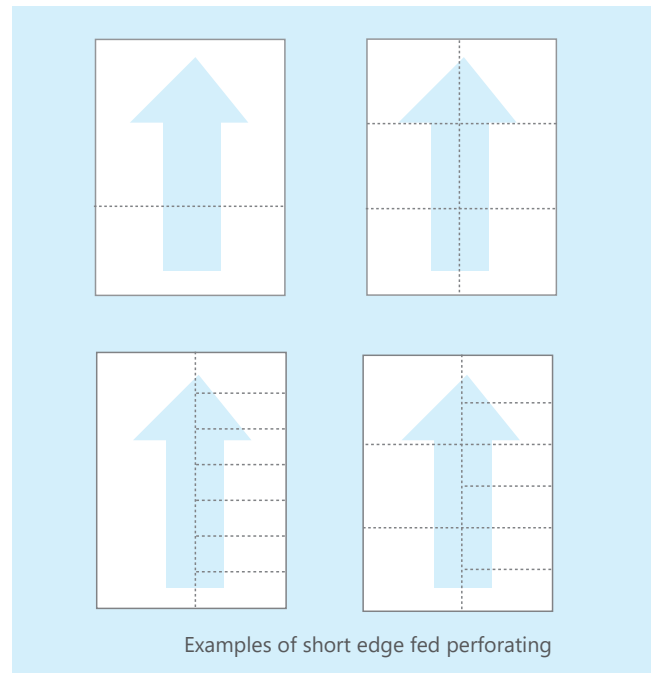
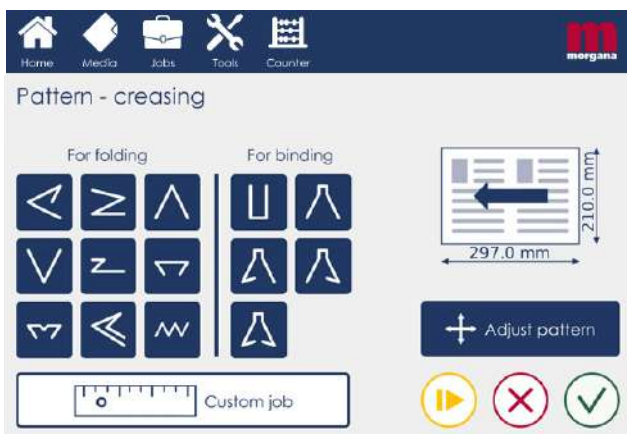

Morgana AutoCreaser Pro XW

The **AutoCreaser Pro XW**, a **high speed** creaser with **SmartScreen** technology.

Morgana AutoCreaser Pro XW

The AutoCreaser Pro XW, made in the UK by Morgana, provides the complete solution to the problem of cracking that occurs when folding digitally printed output. It is equally effective in dealing with conventionally printed card, laminates or cross-grained stock.

The new intuitive 7" SmartScreen controls all the main functions of the AutoCreaser Pro XW. Using the screen is simplicity itself. Key in the sheet length (popular sizes are pre-set), touch the fold type for the finished product (letter, gate etc) and press the green button. The AutoCreaser Pro XW will automatically calculate where the creases need to be and set them accordingly.

Any minor changes to the crease position can be made by touching an arrow in the relevant direction. The productivity of the AutoCreaser Pro XW has been improved with a massive 30% increase in speed with no loss of accuracy. Now running at 8,500 A4 sheets per hour, and at an impressive 11,000 A5 sph this is our most productive creaser to date. The increased sheet size of 700mm x 500mm can be extended with an optional tray making sheet lengths of 900mm possible

Key Features

- 7" SmartScreen touch screen
- 700mm x 500mm sheet size
- Intuitive and easy to use
- Fully automatic
- Up to 16 creases per sheet
- Takes stock up to 0.4mm (approx 400 gsm)*
- Rule and matrix guaranteed for life
- 8500 sheets per hour
- Unlimited alpha numeric memory
- Adjustable crease depth & square
- Full Cross perf capability (up to 500mm)



Easy to use SmartScreen technology.



Morgana AutoCreaser Pro XW

AutoCreaser Pro XW

The AutoCreaser Pro XW has the new Morgana PosiFeed feeding system. The drum stops as the vacuum pulls the sheet down before the drum starts to feed. This significant change will enable the feeder to be piled higher and feed the most difficult of stocks.

All settings and adjustments are made using the new SmartScreen and as only symbols are used, operation couldn't be simpler. An alphanumeric memory allows an unlimited number of jobs to be stored and named as you choose. This makes job recall much easier as you can use your own job name and numbers for storage.

An alpha-numeric memory allows an unlimited number of jobs to be stored and named as you choose. This makes job recall much easier as you can use your own job name and numbers for storage.

Any changes to the suction drum, feed method, crease position and engineering settings are all made through the SmartScreen which have been developed and designed to make the AutoCreaser Pro XW the easiest machine to operate whilst offering levels of sophistication never before seen at this price point.

The New AutoCreaser Pro XW is now fitted with a NEW 'EasyBlade' creasing assembly. This can be removed or changed easily without needing any tools, making it our most productive creaser to date.

Perforation comes as standard on the AutoCreaser Pro range with a wide variety of wheels available to suit all applications.

Creasing rule and matrix

The AutoCreaser Pro XW uses an identical mechanism to all other creasers in the range including the DigiFold Pro and is guaranteed for life. With thousands of these mechanisms installed throughout the world our creasing technology is unparalleled in both performance and longevity.



Images above, showing the removal of the 'EasyBlade' safety cover.

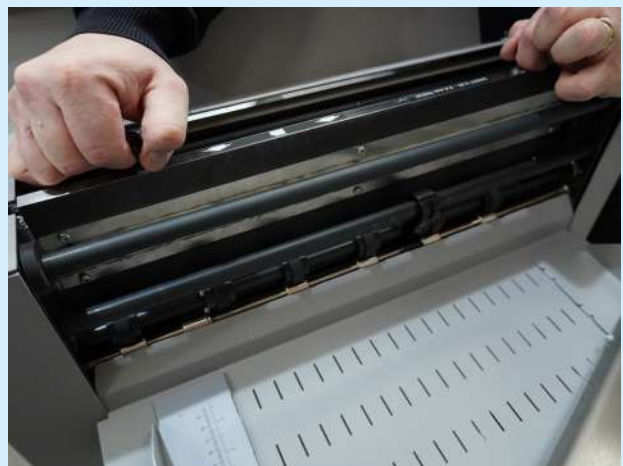

Images showing the removal of 'EasyBlade quick release mechanism'.

Morgana DigiFold Pro XL

Our **DigiFold Pro XL** with new vacuum feeder, running at **6,000 A4** half fold sheets per hour, with **no** loss of **accuracy**.



Morgana DigiFold Pro XL

The DigiFold Pro XL is the latest addition to the Morgana DigiFold family. Developed on the well proven Morgana DigiFold Pro, built with our unique, open design, suction feeder that handles stock sizes from 210 – 1300mm in length. This heavy-duty automatic creasing and folding system is designed to complement mid to high volume digital and offset production presses.

The Morgana DigiFold Pro XL is designed to complement the long sheet capabilities enabled in the production printers of today. It features a standard pull-out extension that enables sheet sizes up to 1300mm. This opens the door to new applications, such as covers for landscape booklets, book covers for oversized perfect bound books, multi-panel brochures and many other applications made from these long sheets.

The DigiFold Pro XL is equipped with the latest version of Morgana's DynaCrease. The creasing blades can now be easily changed without the use of tools. An additional static crease option can be installed to enable the full range of crease and perforation options, such as tear out coupons and reply cards.

Morgana DigiFold Pro XL Key Features

- Folds up to 6,000 A4 per hour / crease only - 7,500 per hour
- Max loading capacity up to 200 mm
- Top fed vacuum feeder, ensures stable production for long runs.
- Fully automatic operator functions. Key in sheet size, media type and thickness and the Pro XL will automatically set speed, roller gap and fan settings
- A unique air knife system for sheet separation.
- Full cross perforation available, plus up to five inline perforation/scoring wheels.
- Up to 30 creases per sheet (static crease)
- Equipped with both a belt-stacker for folded sheets and a delivery tray for crease only jobs.



The Easyblade quick release mechanism enables changing crease blade for different jobs, without any special tools in less than 30 seconds. Extremely useful when changing between a perforation job and a creasing job.



"An additional static crease option can be installed to enable the full range of crease and perforation options"

Morgana DigiFold Pro XL

Intuitive user interface

An intuitive colour touch screen with a run screen that gives you a complete overview of the job in progress. Basic adjustments can be made "on the run" and access to crease and fold patterns is simple. The user interface is available in multiple languages. With new 'Auto-settings', this truly unique function takes care of the roller gap settings, speed adjustment and fan settings, removing time-consuming adjustments of various settings.

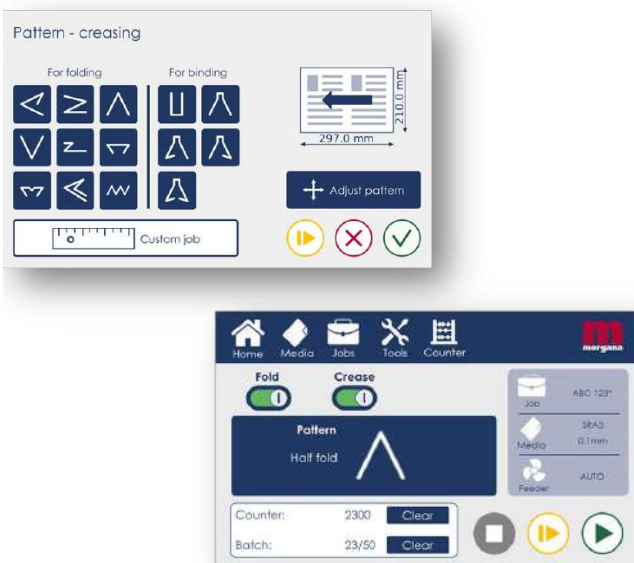

Open design feeder

The system is engineered to simplify the loading and unloading of long "slippery" stacks of paper. The loading and unloading areas are an open design to make it easy to monitor performance and make changing from job to job fast and efficient. The new open feeder design is capable of efficiently feeding a wide range of media types and weights. Equipped with automated vacuum feed technology, specifically designed to handle the widest range of preprinted media.

The Morgana DigiFold Pro XL comes with a fully automatic belt stacker for folded sheets. It also has a catch tray capable of stacking up to 900mm long sheets in the standard configuration.

The two-in-one stacker combination let's you switch between crease or fold jobs from the user interface, no need to reconfigure the machine.

The DigiFold Pro XL can be connected to the BST-4000 Beltstacker for increased stacking capability and easier handling of batch folded sheets.



The DigiFold Pro XL connected with the BST-4000 Beltstacker

Integrated storage

There is also a large storage shelf located below the feed bed in the back of the Pro XL, the tool kits that are included are located here. There is also enough space to store the feed deck extension table when it's not needed, plus room to store accessories such as crease and perforation tools in the integrated storage shelves.



Creasing styles

Folding & Creasing styles

AutoCreaser Pro XL and AutoCreaser Pro XW

DigiFold Pro XL

Creasing on covers for perfect binding



One crease (for a thin book) Two creases (spine only) Four creases (spine and hinge)



Five creases for spine, hinge and flap Four creases for flat spine, hinge and flap

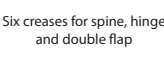

Six creases for spine, hinge and double flap

Folding Patterns



Parallel Fold Accordion Fold Short Fold



Letter Fold Double Parallel Fold



Open Gate Fold Open Gate Fold with creased line

Creasing on covers for perfect binding



One crease (for a thin book) Two creases (spine only) Four creases (spine and hinge)



Five creases for spine, hinge and flap Four creases for flat spine, hinge and flap

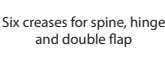

Six creases for spine, hinge and double flap

Folding Styles



Parallel Fold Accordion Fold Short Fold



Letter Fold Double Parallel Fold



Open Gate Fold Open Gate Fold with creased line

* Optional second/crease/perforation tool required for some applications



Perforation

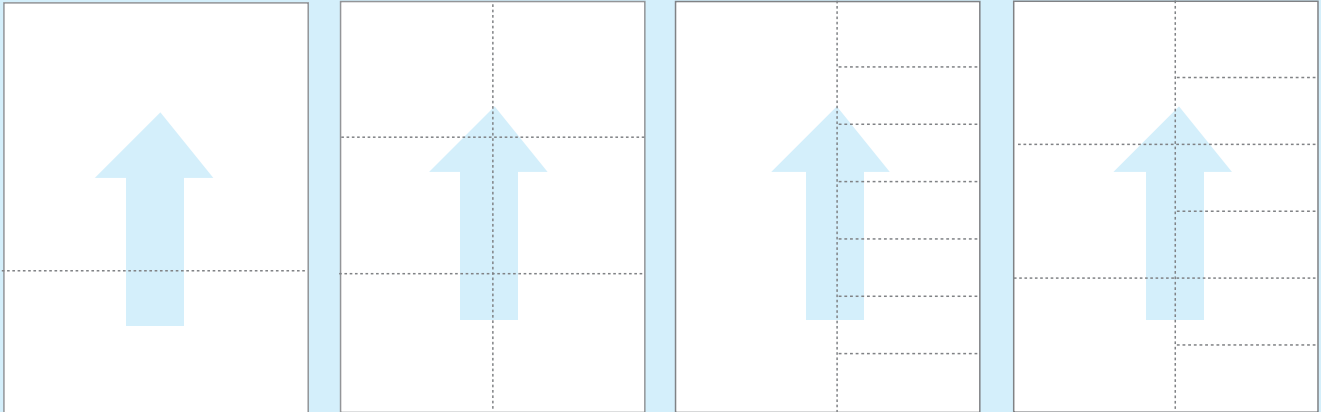

Examples of short edge fed perforating with optional perforation blade

* The above perforation pattern requires 2 passes on the DigiFold Pro XL, XW or single pass on the AutoCreaser Pro XL



Perforated sheets are easy to achieve with Morgana's AutoCreaser Pro XL, XW & DigiFold Pro XL.

Machine Footprints

Morgana AutoCreaser Pro XL



Morgana AutoCreaser Pro XW

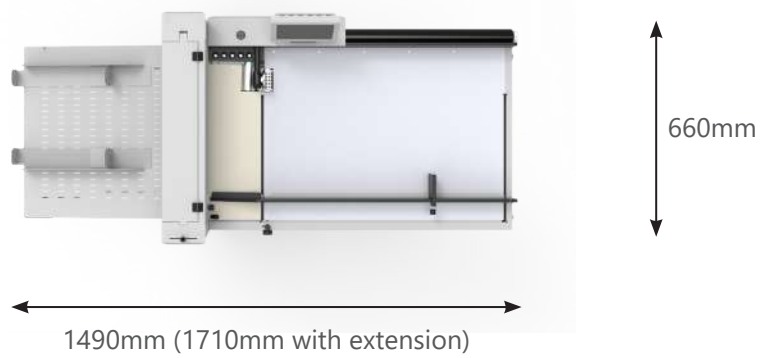

Morgana DigiFold Pro XL

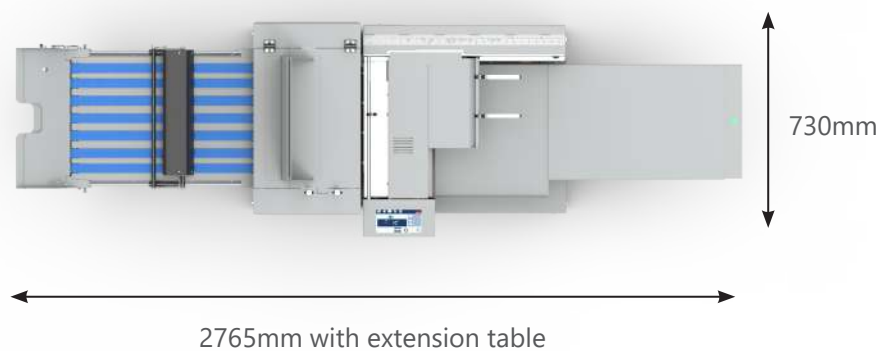

Technical Specifications

AutoCreaser Pro XL

Maximum number of creases / sheets	30 (Up to 60 when 2 creasers are fitted)
Maximum productivity	8500 Sheets per hour (single crease)
Number of crease tools	1 standard, optional 2nd creaser tool
Maximum load capacity	200 mm
Minimum distance between creases	0.1mm
Media range	0.1 - 0.4mm (approx 80 - 400gsm)
Sheet size: max	385 x 700 mm (385 x 1300 mm with table extension)
Sheet size: min	93 x 210 mm
Inline perforation	Standard
Cross perforation	Optional
Feed technology	Vacuum belt top fed with Advanced Process Control (APC)
Weight	305kg incl. packing

AutoCreaser Pro XW

Maximum number of creases / sheets	30 (Up to 60 when 2 creasers are fitted)
Maximum productivity	8500 Sheets per hour (single crease)
Number of crease tools	1 standard, optional 2nd creaser tool
Maximum load capacity	200 mm
Minimum distance between creases	0.1mm
Media range	0.1 - 0.4mm (approx 80 - 400gsm)
Max media thickness for perf	0.11mm / 0.004" up to 0.2mm / 0.008" (depending on paper type)
Sheet size: max	700mm x 500mm (27.5" x 19.7")
Sheet size: min	210mm x 140mm (8.5" x 5.5")
Inline perforation	Standard
Cross perforation	Full Cross perf capability (all the way up to 500mm)
Feed technology	Vacuum belt top fed with Advanced Process Control (APC)
Weight	305kg incl. packing

DigiFold Pro XL

Maximum number of creases / sheets	30 (with optional static creasing tool)
Maximum productivity	6000 Sheets per hour, A4/half fold, one crease only 7,500. DynaCrease standard, Static crease optional
Dual folding knives	Yes
Number of crease tools	Up to two. One DynaCrease and one static crease optional
Maximum load capacity	200 mm
Minimum distance between creases	0.1 mm with static crease (2.5mm with DynaCrease)
Media range	0.1 - 0.4mm (approx 80 - 400gsm)
Sheet size: max	385 x 700 mm (385 x 1300 mm with table extension)
Sheet size: min	93 x 210 mm
Inline perf	Standard
Cross perf	Optional (comes with static crease kit)
Feed technology	Vacuum belt top fed with Advanced Process Control (APC)
Weight	368kg incl. packing

AutoCreaser Pro XL : AutoCreaser Pro XW : DigiFold Pro XL